





2 JUNIOR SOCCER GOAL SET

COMPONENT CHECKLIST AND ASSEMBLY INSTRUCTIONS

COMP No.	Q'TY	COMP No.	Q'TY
A:  B: 	4 PCS + 4 PCS	POLE: Ø25.4mm, L 70cm	4 PCS
C:  E: 	4 PCS + 4 PCS	POLE: Ø25.4mm, L 61cm	4 PCS
GOAL NET	2	POLE: Ø25.4mm, L 55cm	4 PCS
	4 + 4	POLE: Ø25.4mm, L 41cm	4 PCS
6" P.V.C. BALL	1 PCS	POLE: Ø25.4mm, L 15cm	4 PCS
8" PUMP+PIN	1 PCS		

Instruction for Goal Only

1. Assemble A, B, C, E.

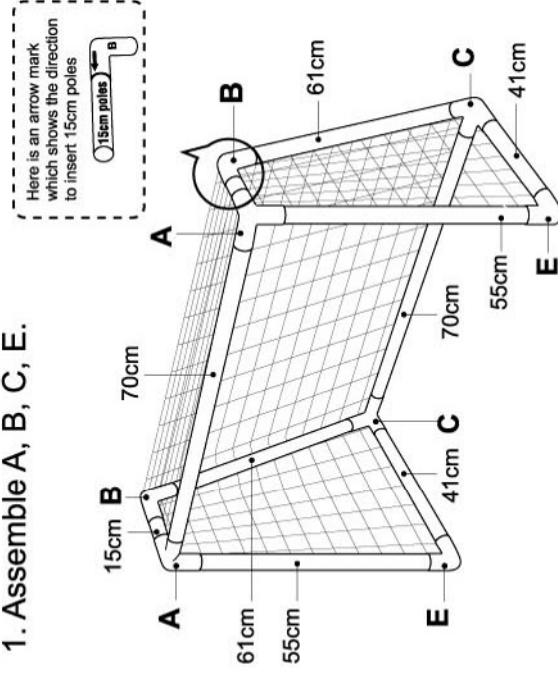

Finished

4. Use (F) metal stakes to secure the goal set.

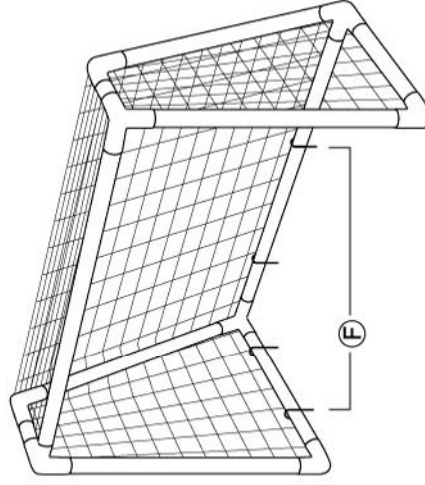

GOAL SIZE: L74 x H60 x D46 cm

Net on the Goal

2. Make sure the 2 red tags are at the top of the soccer goal.
3. Then take the net (E) and weave it through the top, sides, and bottom of the poles to secure the net.

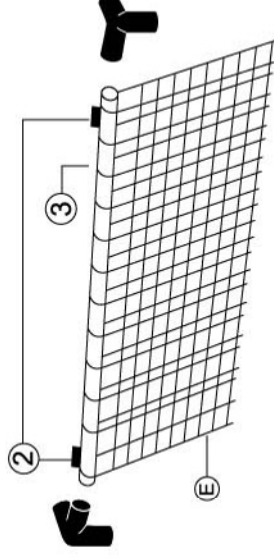

TO BE ASSEMBLED AND DISASSEMBLED BY AN ADULT.

! WARNING:
CHOKING HAZARD - Small parts.
 Not for children under 3 years.



MADE IN TAIWAN